

For cold cathode low pressure mercury lamps
For Ultraviolet rays point type irradiator UVP-60
Manual power supply controller

UVPC-1500V series

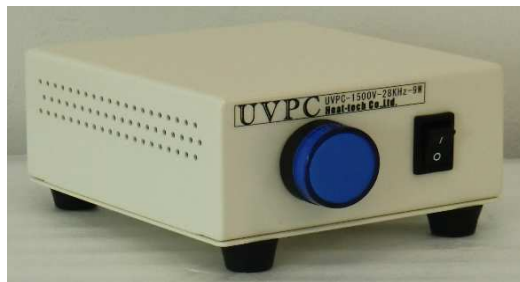

Heat-tech

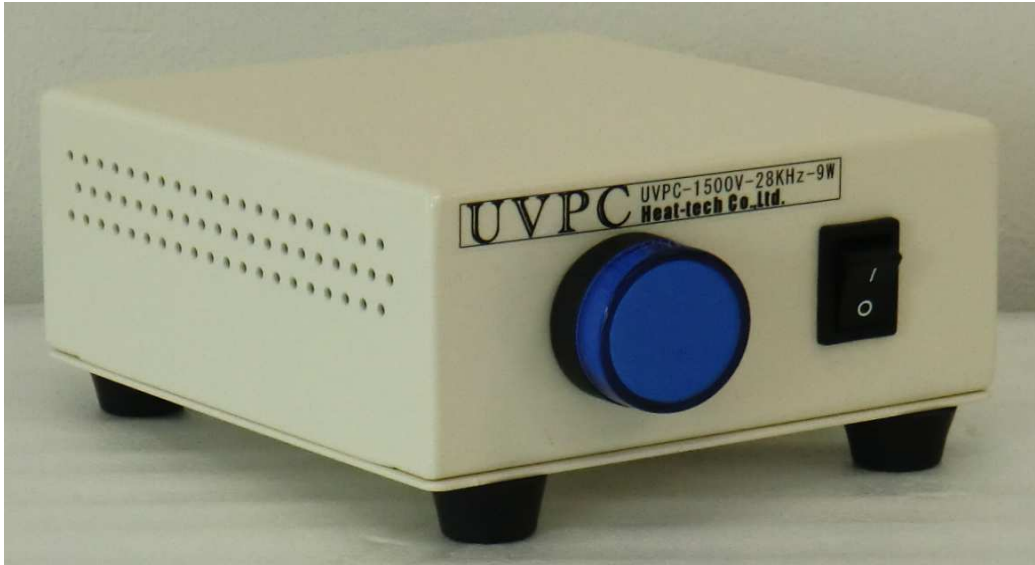

Color universal design UVPC-1500V series

A blue indicator light has been adopted to make it easy for anyone to see. It has a built-in inverter and can light UVP-60 and cold cathode type ultraviolet lamps.

Note - Cannot be used for UVP-30.

【Specifications】

D/#	Input Vpltage	Output Voltage	Current
UVPC-1500V	AC100~240V	Max. 1500V rms	Max. 20mA

Paid additional specifications

D/#	Item and Description
FPR	Front Protection Rail
RPR	Rear Protection Rail
LH	Lifting Handle
Power Cable	Manufacture the specification of the power cable.

[Usage example: UV point type irradiator UVP-60]

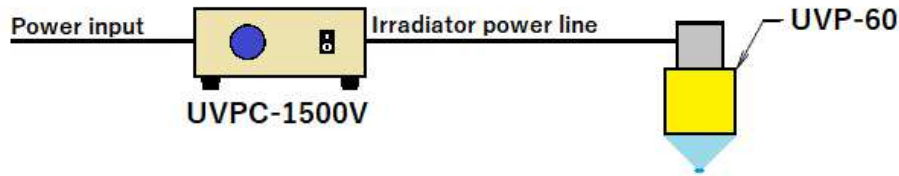

[Usage example:
UV point type irradiation device UVP-60 2 unit control]

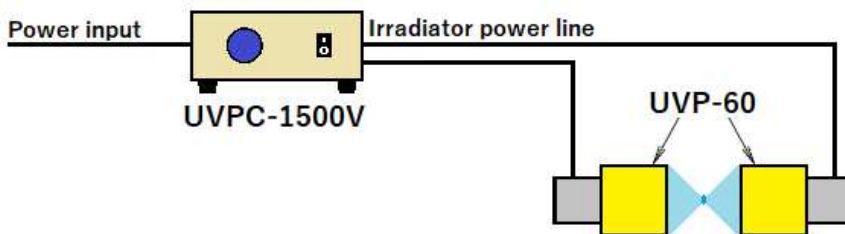

[Usage example: cold cathode UV lamp control]

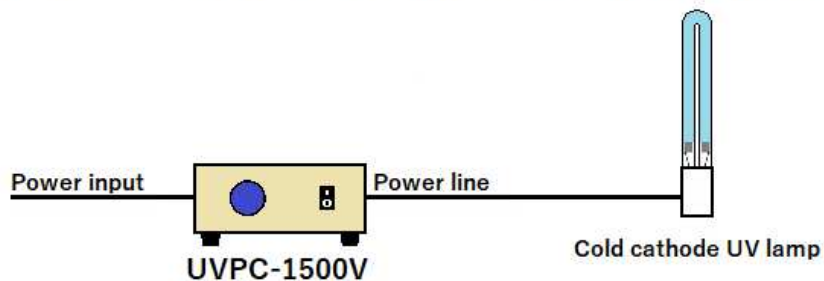

[Usage example: Control of 2 cold cathode UV lamps]

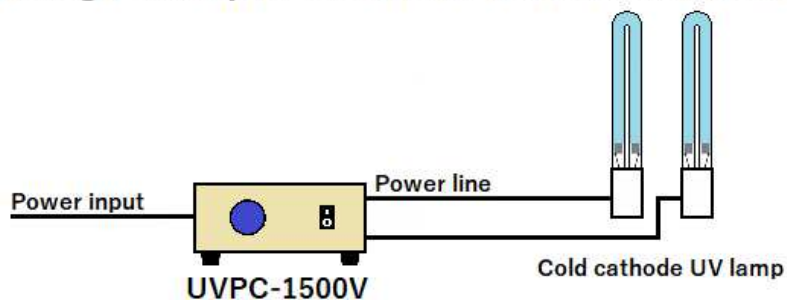

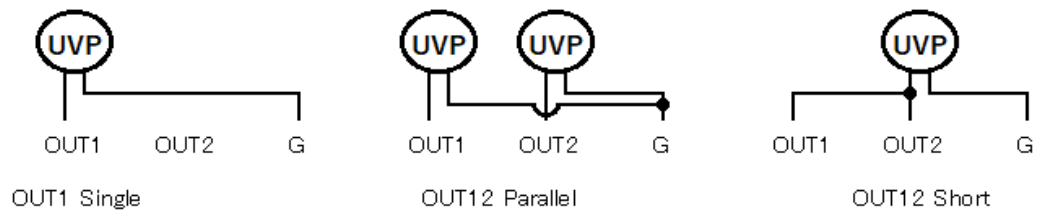
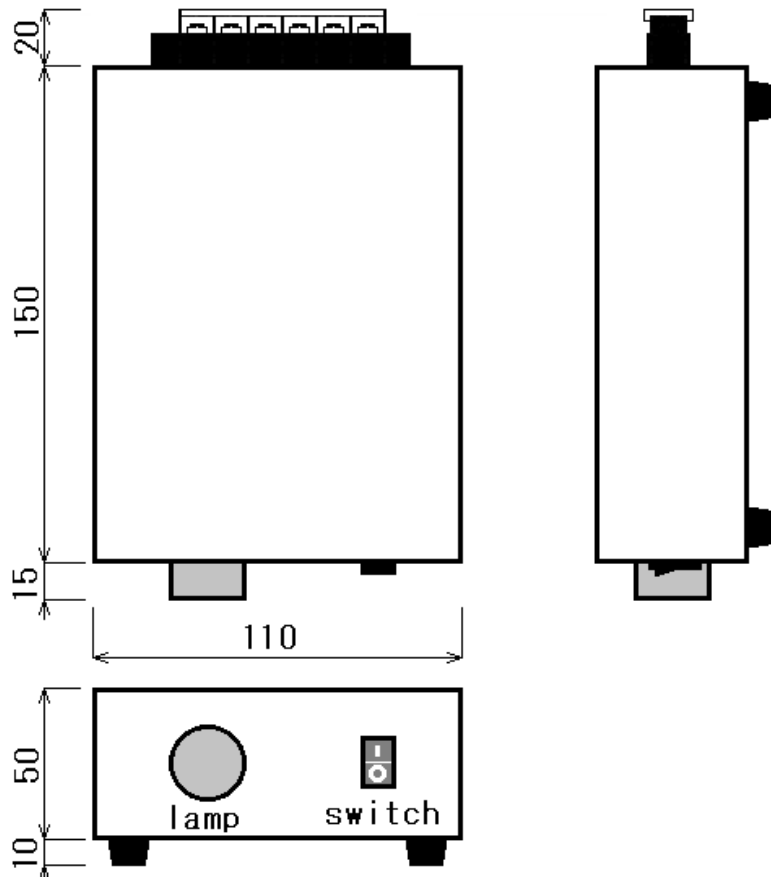

Input (V)	AC100V-240V		
Open circuit voltage	1500V rms		
Connection type	OUT1 Single	OUT12 Parallel	OUT12 Short
Output (A)	12mA rms	10mA rms	20mA rms
Output (W)	5.4W	4.5W	9W
Frequency	32KHz	28KHz	28KHz
D/#	UVPC-1500V		
Model	Power supply controller for Ultraviolet rays point type irradiator UVP-60		

Date
2022.10.11

Heat-tech

No-touch High Temperatures Hating

Heat-tech

Heat-tech Co., Ltd.

<https://heater.heat-tech.biz>

International Medical Device Alliance IMDA

1-6-5 Minatojima Minamimachi Chuoku Kobe 650-0047 Japan

TEL 81-78945-7894 FAX 81-78945-7895

E-mail info@heat-tech.biz